

Please write clearly in block capitals.

Centre number

--	--	--	--	--

Candidate number

--	--	--	--

Surname

---

Forename(s)

---

Candidate signature

---

# GCSE MATHEMATICS

# H

Higher Tier

Paper 1 Non-Calculator

Thursday 25 May 2017

Morning

Time allowed: 1 hour 30 minutes

## Materials

For this paper you must have:

- mathematical instruments.

You must **not** use a calculator.

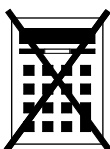

## Instructions

- Use black ink or black ball-point pen. Draw diagrams in pencil.
- Answer **all** questions.
- You must answer the questions in the spaces provided. Do not write outside the box around each page or on blank pages.
- Do all rough work in this book. Cross through any work you do not want to be marked.

## Information

- The marks for questions are shown in brackets.
- The maximum mark for this paper is 80.
- You may ask for more answer paper, graph paper and tracing paper. These must be tagged securely to this answer book.

For Examiner's Use

Pages	Mark
2–3	
4–5	
6–7	
8–9	
10–11	
12–13	
14–15	
16–17	
18–19	
20–21	
22–23	
24–25	
<b>TOTAL</b>	

## Advice

- In all calculations, show clearly how you work out your answer.



JUN1783001H01

Answer **all** questions in the spaces provided

- 1 Simplify  $2^5 \times 2^3$   
Circle your answer.

[1 mark]

$4^8$

$2^8$

$2^{15}$

$4^{15}$

2

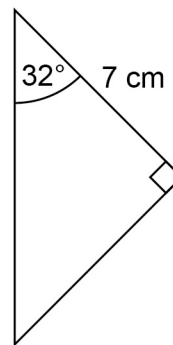
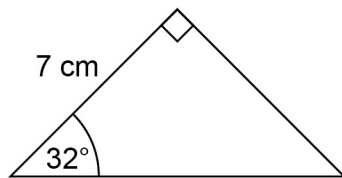

Not drawn  
accurately

Circle the reason why these triangles are congruent.

[1 mark]

SSS

SAS

ASA

RHS

- 3 Which of these is a geometric progression?  
Circle your answer.

[1 mark]

2, 4, 6, 8, 10

2, 3, 5, 8, 12

2, 6, 18, 54, 162

2, 6, 10, 14, 18



4  $a : b = 4 : 3$

Circle the correct statement.

[1 mark]

$b$  is  $\frac{4}{7}$  of  $a$

$b$  is  $\frac{3}{7}$  of  $a$

$b$  is  $\frac{4}{3}$  of  $a$

$b$  is  $\frac{3}{4}$  of  $a$

5 Write 36 as a product of prime factors.

Give your answer in index form.

[3 marks]

Answer \_\_\_\_\_

**Turn over for the next question**

7

**Turn over ►**



- 6 The table shows information about the times for 10 people to complete a task.

Time, $t$ (minutes)	Frequency
$0 < t \leq 20$	1
$20 < t \leq 40$	6
$40 < t \leq 60$	3

These statements are about the mean and range of the actual times.

Tick the correct box for each statement.

[4 marks]

	True	False
The mean could be less than 20 minutes	<input type="checkbox"/>	<input type="checkbox"/>
The mean could be more than 40 minutes	<input type="checkbox"/>	<input type="checkbox"/>
The mean could be less than 40 minutes	<input type="checkbox"/>	<input type="checkbox"/>
The range could be more than 40 minutes	<input type="checkbox"/>	<input type="checkbox"/>
The range could be less than 40 minutes	<input type="checkbox"/>	<input type="checkbox"/>
The range could be more than 60 minutes	<input type="checkbox"/>	<input type="checkbox"/>



7  $\frac{3}{5}$  of a number is 162

Work out the number.

[2 marks]

---

---

---

---

---

Answer \_\_\_\_\_

8  $x$  km/h =  $y$  mph

Use  $8$  km/h =  $5$  mph to write a formula for  $y$  in terms of  $x$ .

[2 marks]

---

---

---

Answer \_\_\_\_\_

**Turn over for the next question**



9 (a) Density =  $\frac{\text{mass}}{\text{volume}}$

The mass of solid A is 6 times the mass of solid B.

The volume of solid A is 3 times the volume of solid B.

Complete the sentence.

[1 mark]

The density of solid A is \_\_\_\_\_ times the density of solid B.

9 (b) Average speed =  $\frac{\text{distance}}{\text{time}}$

If the distance is halved and the time is doubled, what happens to the average speed?

Circle your answer.

[1 mark]

$\times 2$

$\times 4$

no change

$\div 2$

$\div 4$



**10** Solve the simultaneous equations.

$$2x + y = 18$$

$$x - y = 6$$

**[3 marks]**

---

---

---

---

---

---

---

---

---

---

Answer \_\_\_\_\_

**Turn over for the next question**



- 11** Billy wants to buy these tickets for a show.  
4 adult tickets at £15 each  
2 child tickets at £10 each

A 10% booking fee is added to the ticket price.

3% is then added for paying by credit card.

Work out the **total** charge for these tickets when paying by credit card.

**[5 marks]**

---

---

---

---

---

---

---

---

---

---

---

Answer £ \_\_\_\_\_





12 Here is a circle touching a square.

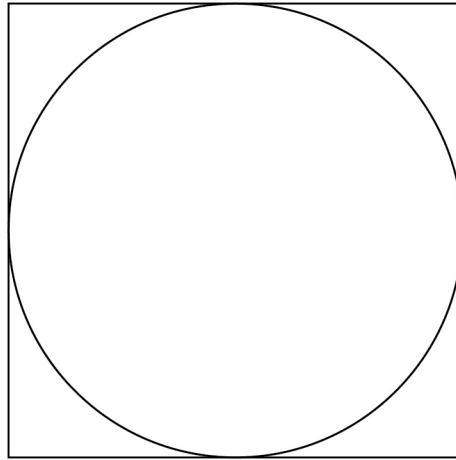

Not drawn  
accurately

The area of the square is  $64 \text{ cm}^2$

Work out the area of the circle.

Give your answer in terms of  $\pi$ .

[3 marks]

---

---

---

---

Answer \_\_\_\_\_  $\text{cm}^2$

Turn over for the next question



- 13** Write the number six million five thousand two hundred in standard form. **[2 marks]**

---

---

---

Answer \_\_\_\_\_

- 14** Solve  $-3x > 6$  **[1 mark]**

---

---

Answer \_\_\_\_\_

- 15**  $\frac{1}{6}$ ,  $\frac{1}{7}$ ,  $\frac{1}{8}$  and  $\frac{1}{9}$  are four fractions.

How many of these fractions convert to a recurring decimal?

Circle your answer.

**[1 mark]**

0                      1                      2                      3                      4



- 16** A fair spinner has five equal sections numbered 1, 2, 3, 4 and 5  
A fair six-sided dice has five red faces and one green face.  
The spinner is spun.  
If the spinner shows an even number, the dice is thrown.

- 16 (a)** Complete the tree diagram for the spinner and the dice.

**[2 marks]**

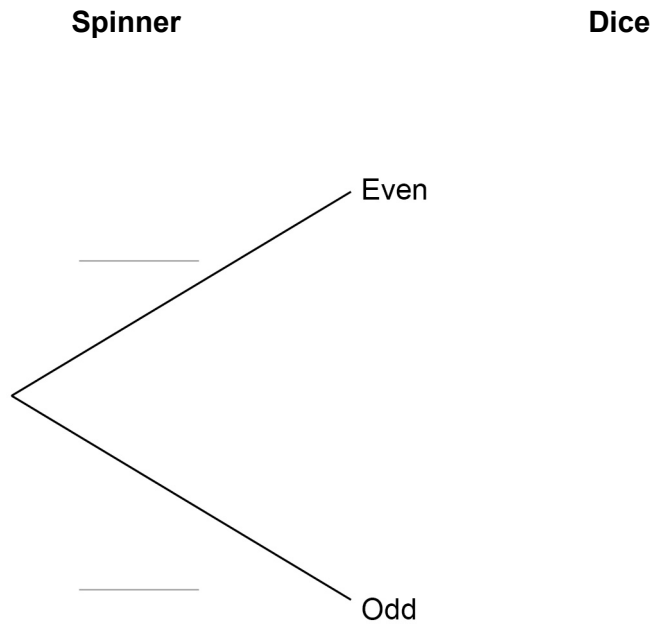

- 16 (b)** Work out the probability of getting an even number and the colour green.

**[2 marks]**

---



---

Answer \_\_\_\_\_



**17**      $A$  is the point  $(2, -5)$   
          $B$  is the point  $(4, -9)$

**17 (a)**     Show that the gradient of the straight line passing through  $A$  and  $B$  is  $-2$

**[2 marks]**

---

---

---

**17 (b)**      $C$  is the point  $(-301, 601)$

Does  $C$  lie on the straight line passing through  $A$  and  $B$ ?

You **must** show your working.

**[2 marks]**

---

---

---

---

---

---

---

Answer \_\_\_\_\_





- 19** Here is some information about the marks of 60 students in a test.

Mark, $m$	Frequency		
$40 < m \leq 50$	9		
$50 < m \leq 60$	16		
$60 < m \leq 70$	20		
$70 < m \leq 80$	8		
$80 < m \leq 90$	7		

- 19 (a)** On the grid, draw a cumulative frequency graph.

**[3 marks]**

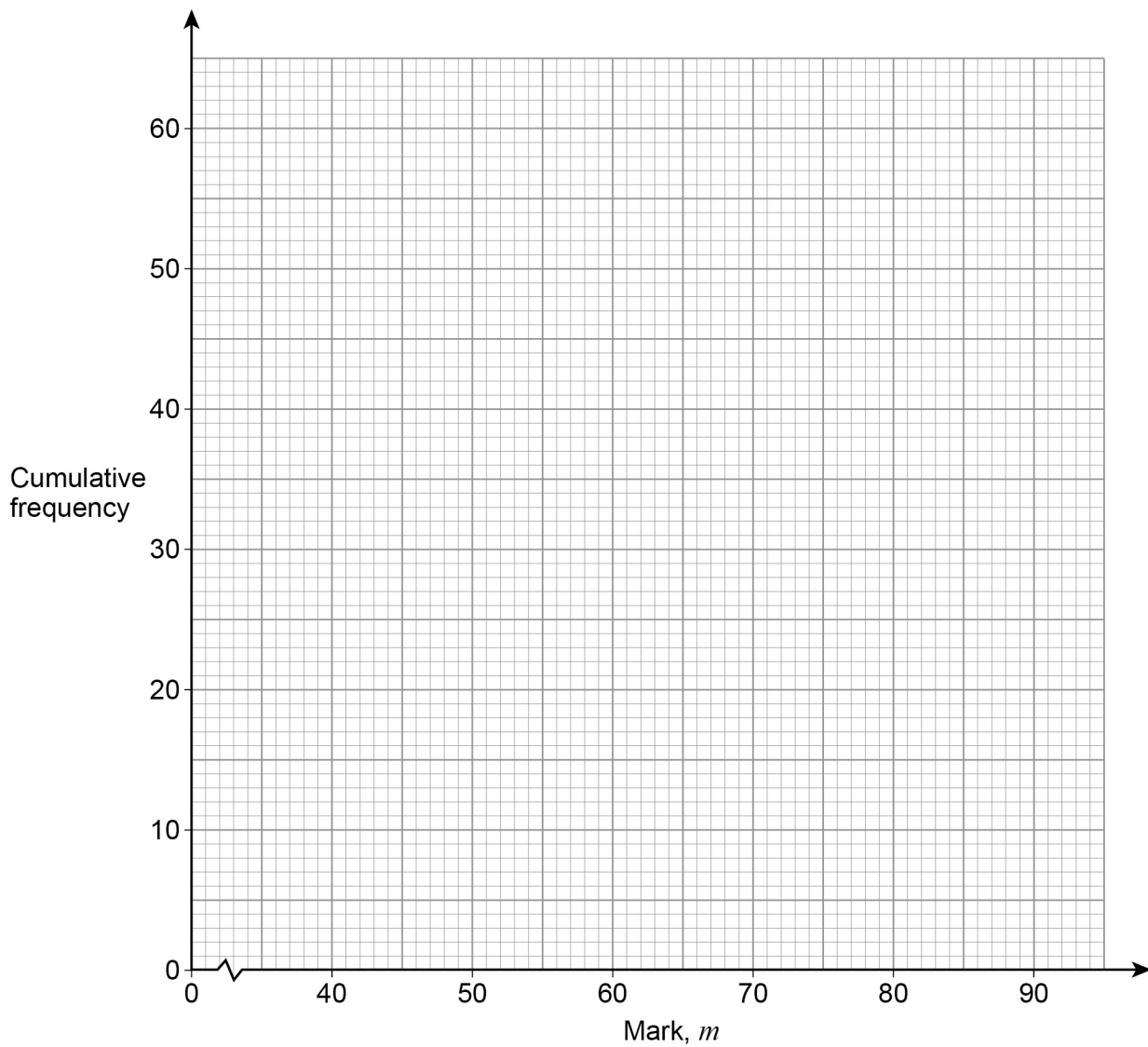

**19 (b)** Use your graph to estimate the lowest mark of the top 20% of students.

**[2 marks]**

---

---

---

Answer \_\_\_\_\_

**20** Work out the diameter of the circle  $x^2 + y^2 = 64$

Circle your answer.

**[1 mark]**

8                  16                  32                  128

**Turn over for the next question**



21 (a) The diagram shows rectangles A and B.

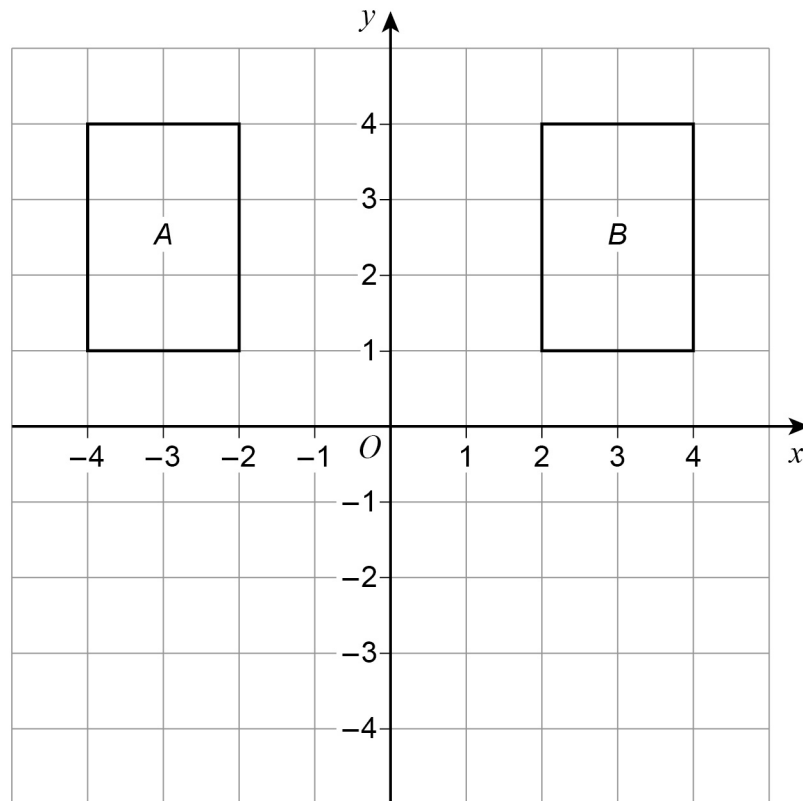

Rectangle A can be mapped to rectangle B by a **single** transformation.

Javed says,

“The **only** single transformation is a reflection in the  $y$ -axis because the rectangles are on opposite sides of the  $y$ -axis.”

Is he correct?

Tick a box.

Yes

No

Give a reason for your answer.

[1 mark]

---



---



---





21 (b) This diagram shows triangles  $CDE$  and  $PQR$ .

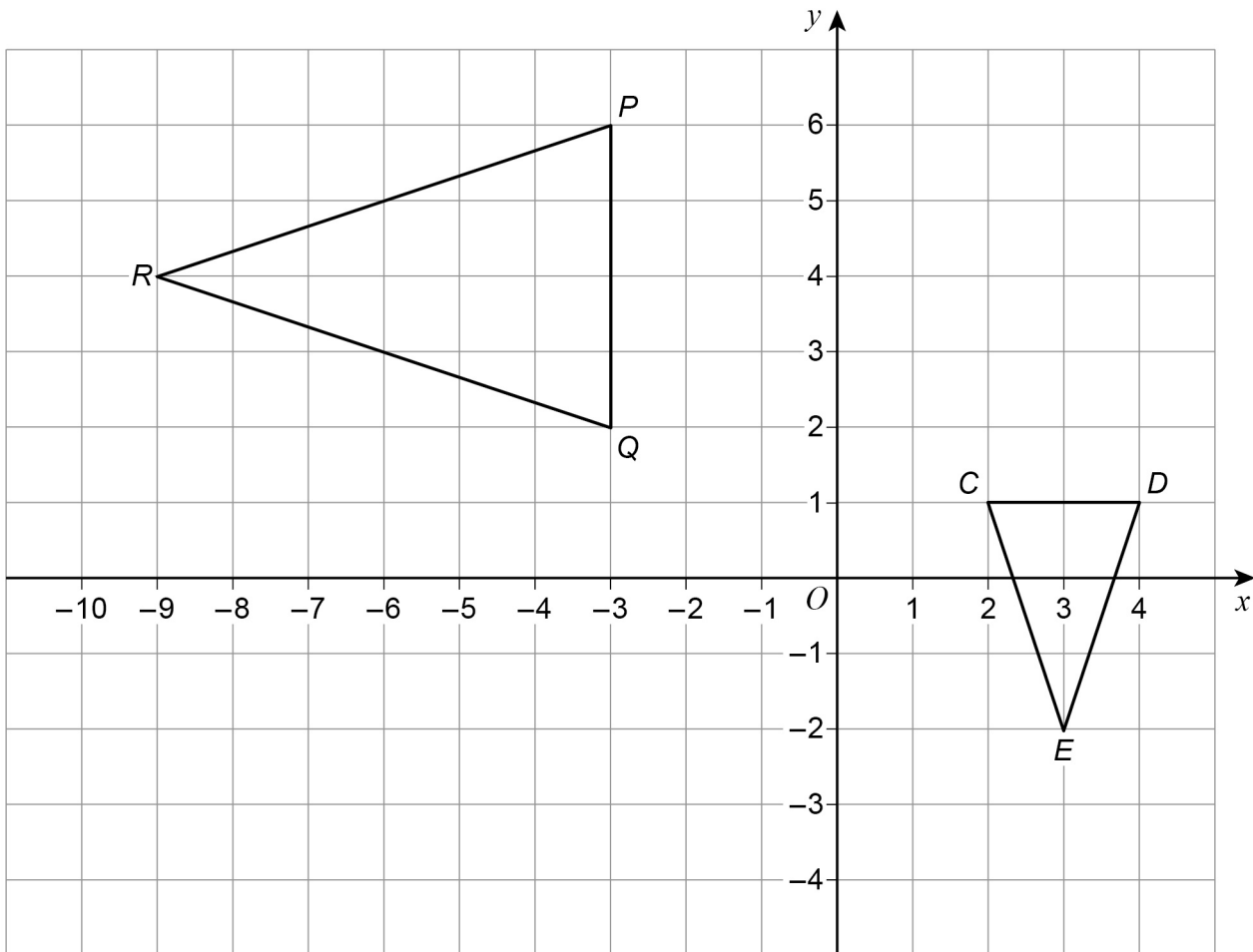

$CDE$  is mapped to  $PQR$  by combining two single transformations.

The first is a rotation of  $90^\circ$  anticlockwise about  $E$ .

Describe fully the second transformation.

[3 marks]

---



---



---

Turn over for the next question

Turn over ►

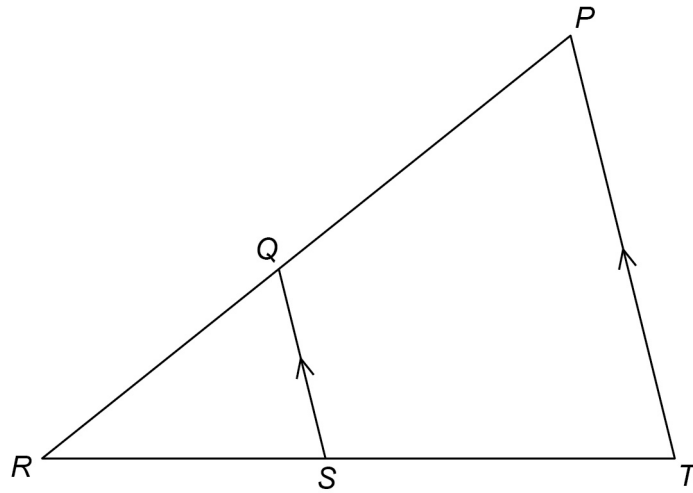

22

 $PRT$  and  $QRS$  are similar triangles.Not drawn  
accuratelyWhich of these is equivalent to  $\frac{QR}{PR}$ ?

Circle your answer.

[1 mark]

$$\frac{RS}{ST}$$

$$\frac{QS}{PT}$$

$$\frac{PT}{QS}$$

$$\frac{RT}{RS}$$



23

Here is a velocity-time graph of a motorbike for 25 seconds.

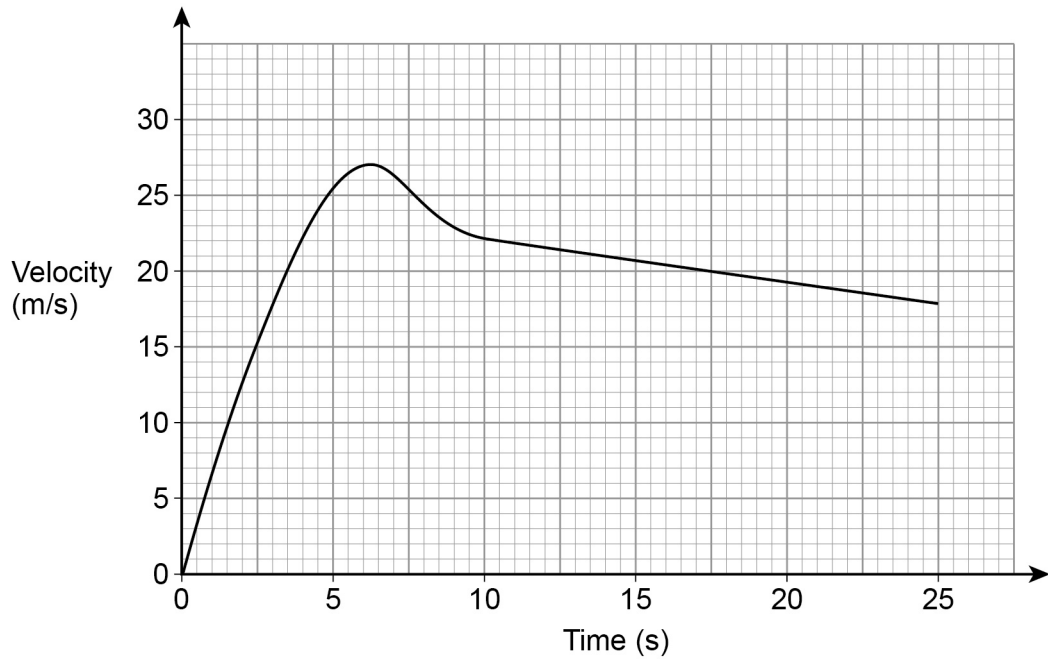

23 (a) After how many seconds was the acceleration zero?

[1 mark]

Answer \_\_\_\_\_ seconds

23 (b) Work out the distance travelled in the last 15 seconds.

[2 marks]

---



---



---



---

Answer \_\_\_\_\_ metres

Turn over ►



24 (a) Work out  $\sqrt{12\frac{1}{4}}$  as an improper fraction.

[1 mark]

---

---

Answer \_\_\_\_\_

24 (b) Work out  $\sqrt[3]{16}$  as a power of 2

[2 marks]

---

---

---

---

---

Answer \_\_\_\_\_





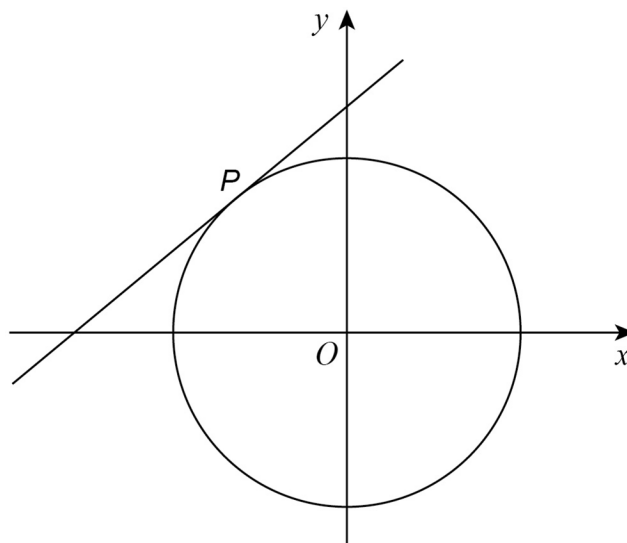

27

 $P(-1, 4)$  is a point on a circle, centre  $O$ Not drawn  
accuratelyWork out the equation of the tangent to the circle at  $P$ .Give your answer in the form  $y = mx + c$ **[4 marks]**

---

---

---

---

---

---

---

---

---

---

Answer \_\_\_\_\_

8

Turn over ►



28

Volume of cone =  $\frac{1}{3}\pi r^2 h$  where  $r$  is the radius and  $h$  is the perpendicular height.

A cone has a

horizontal base of radius 5 cm

height of 15 cm

The cone contains water to a depth of 9 cm

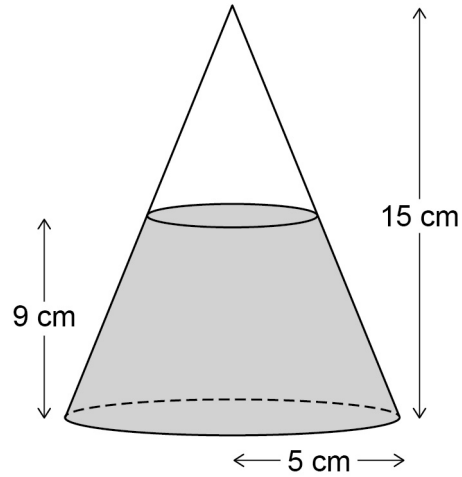

Work out the volume of the water, in  $\text{cm}^3$

Give your answer in terms of  $\pi$ .

[4 marks]

---



---



---



---



---



---



---



---



---



---



---



---



---



---



---



---

Answer \_\_\_\_\_  $\text{cm}^3$





29 Simplify  $\frac{2 \sin 45^\circ - \tan 45^\circ}{4 \tan 60^\circ}$

Give your answer in the form  $\frac{\sqrt{a} - \sqrt{b}}{c}$  where  $a$ ,  $b$  and  $c$  are integers.

[4 marks]

---

---

---

---

---

---

---

---

---

---

Answer \_\_\_\_\_

**END OF QUESTIONS**



**There are no questions printed on this page**

**DO NOT WRITE ON THIS PAGE  
ANSWER IN THE SPACES PROVIDED**



**There are no questions printed on this page**

**DO NOT WRITE ON THIS PAGE  
ANSWER IN THE SPACES PROVIDED**



**There are no questions printed on this page**

**DO NOT WRITE ON THIS PAGE  
ANSWER IN THE SPACES PROVIDED**

**Copyright Information**

For confidentiality purposes, from the November 2015 examination series, acknowledgements of third party copyright material will be published in a separate booklet rather than including them on the examination paper or support materials. This booklet is published after each examination series and is available for free download from [www.aqa.org.uk](http://www.aqa.org.uk) after the live examination series.

Permission to reproduce all copyright material has been applied for. In some cases, efforts to contact copyright-holders may have been unsuccessful and AQA will be happy to rectify any omissions of acknowledgements. If you have any queries please contact the Copyright Team, AQA, Stag Hill House, Guildford, GU2 7XJ.

Copyright © 2017 AQA and its licensors. All rights reserved.

